



Respironics Inc.  
1001 Murry Ridge Lane  
Murrysville, PA 15668 USA



1067787  
JAW 09/13/2010

© 2010 Koninklijke Philips Electronics N.V. All rights reserved.



EasyLife | INSTRUCTIONS FOR USE

**PHILIPS**  
RESPIRONICS

## Table of Contents

2	Package Contents
3	Intended Use
4	Warnings
6	Symbols
7	Before Use
7	Cleaning Instructions
8	System One Resistance Control
9	Disconnecting and Connecting the Headgear
9	Using the Optional Headgear Clips
10	EasyLife Mask
10	Achieving the Right Fit
12	Comfort Tips
13	Removing the Mask
13	Removing and Attaching the Cushions
15	Specifications
17	Disposal
17	Storage Conditions
18	Warranty
20	Reorder Numbers

## Package Contents

- EasyLife Nasal Mask
- Headgear
- Instructions for Use
- QuickStart Fitting Tips



Note

*Not all packages contain listed items. Please contact your Home Care Provider or Respironics for additional items or replacement parts.*

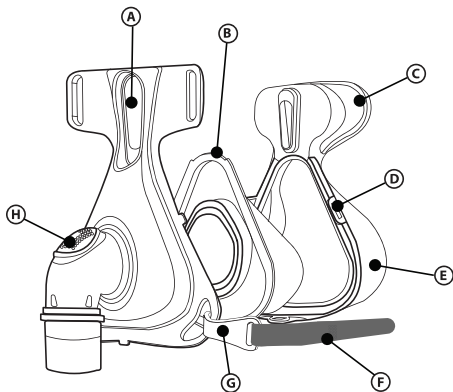

**Figure 1**

- A = Forehead Pad Slot
- B = Inner Sealing Cushion with Blue Flap
- C = Forehead Pad
- D = Attachment Tabs
- E = Outer Support Cushion
- F = Headgear Strap
- G = Headgear Clip (Optional)
- H = Exhalation Chip (Do not block or remove)

 **Caution**

U. S. federal law restricts this device to sale by or on the order of a physician.

**Intended Use**

The EasyLife Nasal Mask is an accessory to a non-continuous ventilator (respirator). The mask is for single patient use in the home or multi-patient use in the hospital/institutional environment. The mask is to be used on patients (>66lbs/30kg) for whom CPAP or bi-level therapy has been prescribed.

 **Important Note:** An exhalation port is built into the EasyLife Nasal Mask so a separate exhalation port is not required.

## Warnings

- This mask is not suitable for providing life support ventilation.
- This mask is designed for use with CPAP or bi-level systems recommended by your health care professional or respiratory therapist. Do not wear this mask unless the CPAP or bi-level system is turned on and operating properly. **Do not block or try to seal the exhalation port.**  
**Explanation of the Warning:** CPAP systems are intended to be used with special masks with connectors which have vent holes to allow continuous flow of air out of the mask. When the CPAP machine is turned on and functioning properly, new air from the CPAP machine flushes the exhaled air out through the attached mask exhalation port. However, when the CPAP machine is not operating, enough fresh air will not be provided through the mask, and exhaled air may be rebreathed. This warning applies to most models of CPAP systems. Rebreathing of exhaled air for longer than several minutes can, in some circumstances, lead to suffocation.
- If oxygen is used with the device, the oxygen flow must be turned off when the device is not operating. **Explanation of the Warning:** When

### Warning

A warning indicates the possibility of injury to the user or operator.

### Caution

A caution indicates the possibility of damage to the device.

### Note







A note places an emphasis on an operating characteristic.

### Warnings (continued)

the device is not in operation, and the oxygen flow is left on, oxygen delivered into the ventilator tubing may accumulate within the device enclosure. Oxygen accumulated in the device enclosure will create a risk of fire.

- Oxygen supports combustion. Oxygen should not be used while smoking or in the presence of an open flame.
- At a fixed flow rate of supplemental oxygen flow, the inhaled oxygen concentration will vary, depending on the pressure settings, patient breathing pattern, mask selection, and the leak rate. This warning applies to most types of CPAP and bi-level machines.
- Some users may experience skin redness, irritation, or discomfort. If this happens, discontinue use and contact your healthcare professional.
- At low CPAP or EPAP pressures, the flow through the exhalation port may be inadequate to clear all exhaled gas from the tubing. Some rebreathing may occur.
- Hand wash prior to first use. Inspect the mask for damage or wear (cracking, crazing, tears, etc). Discard and replace any components as necessary.
- If an additional exhalation device is added to the patient circuit, you may need to adjust the pressure level to compensate for the additional leak of the exhalation device.
- Use of a nasal or full face mask may cause tooth, gum, or jaw soreness or aggravate an existing dental condition. Consult your physician or dentist if symptoms occur.

## Symbols

Symbol	Description
	Consult instructions for use
	General caution or warning
	System One
	Tip
	Note
	Does not contain natural rubber latex
	Does not contain DEHP (bis (2-ethylhexyl) phthalate)

## Before Use

- Read and understand the instructions completely.
- Hand wash the mask.
- Wash your face.
- Do not apply moisturizer/lotion to your face or hands prior to handling/wearing the mask.

## Cleaning Instructions

Hand wash the mask before first use and daily. The headgear should be hand washed weekly, or as needed. The headgear does not need to be removed for daily cleaning of the mask.

1. Hand wash the mask and headgear in warm water with a mild liquid dish washing detergent.

-  **Caution:** Do not use bleach, alcohol, cleaning solutions containing bleach or alcohol, or cleaning solutions containing conditioners or moisturizers.
2. Rinse thoroughly with water and air dry out of direct sunlight. Make sure the mask is dry before use. Lay the headgear flat or line dry. Do not place the headgear into the dryer.

-  **Warning:** Inspect the mask for damage or wear (cracking, crazing, tears, etc). Discard and replace any components as necessary.

For **multi-patient** use in the hospital/institutional environment, use the Mask Cleaning and Disinfection Instructions to reprocess the mask between patients. These instructions can be obtained by visiting [www.philips.com/respironics](http://www.philips.com/respironics) or by contacting Respironics Customer Service at 1-800-345-6443 (USA or Canada) or 1-724-387-4000.



### Philips Respiroics System One Resistance Control

This mask uses the System One Resistance Control setting  ← X1.

This symbol may appear on your Philips Respiroics therapy device.

This symbol represents the level of mask resistance compensation.

Match the setting to the mask as appropriate.

#### Important Notes:

- Verify the System One setting if the mask or mask cushion changes.
- The System One setting is not compatible with masks requiring a separate/additional exhalation device.

If your provider has locked the resistance compensation setting, you can view the setting but cannot change it, and the screen will display a lock symbol. If your provider has disabled the resistance compensation, you will not see this setting.

## Disconnecting and Connecting the Headgear

Thread the headgear strap through the slot in the faceplate (Figure 2). The sticky side will be on the outside while you thread the strap. Fold the strap back and attach the tab to the headgear strap.

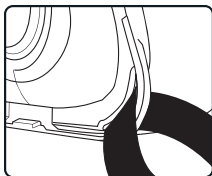

 Figure 2

## Using the Optional Headgear Clips (Figure 3)

1. Remove the headgear straps from the bottom of the faceplate.
2. Attach the clips to the faceplate, by placing the hook of the clips in the slot of the faceplate and pull inwards toward the face.
3. Thread the bottom headgear straps through the clip slots. Fold the straps back and attach the tabs to the headgear straps.
4. To remove the clips from the faceplate, push the clips outward away from the face.

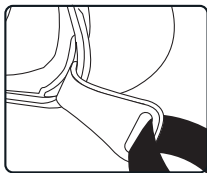

 Figure 3

## EasyLife Mask

The EasyLife Mask is designed with a unique dual-cushion construction.

- The inner cushion creates a self-adjusting seal.
- The outer cushion provides comfortable support. The outer cushion is not designed to provide seal.

### Achieving the Right Fit

1. Hold the mask with the inner cushion over your nose and pull the headgear on over your head. The headgear is preset to a large setting so it can easily go on right out of the package.
2. Evenly adjust the upper straps (Figure 4) to a comfortable position by using the tabs on both sides of the headgear: Do not pull the straps tight. The cushion should lightly touch the face.
3. Evenly adjust the lower straps (Figure 5) to a comfortable position by using the tabs on both sides of the headgear. If using the optional clips, the lower headgear tabs will

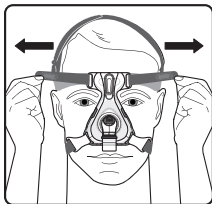

▲ Figure 4

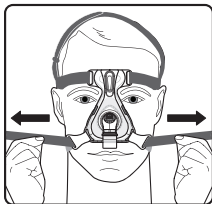

▲ Figure 5

attach near the back of the head. If using the headgear, the tabs will attach under the ears. Do not pull the straps tight.

4. Adjust the top strap (Figure 6) so the upper straps rest above the ears. The headgear should lay flat against the base of the head.
5. Connect the tubing (included with the CPAP or bi-level device) to the tubing swivel.
6. Turn on the airflow.
7. Lie down and breathe normally through your nose, keeping your lips closed.
8. Adjust the headgear evenly to reduce leaks or pressure points at the bridge of the nose or above the lip.
9. Reseat the mask, if necessary.

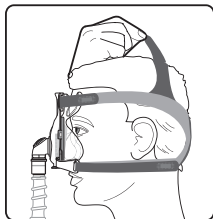

 **Figure 6**



### Comfort Tips

- The headgear should fit both loosely and comfortably. If your skin bulges around the mask, loosen the headgear.
- Reseat the mask. Pull the mask by the sides of the faceplate directly away from the face then gently set it back into place.
- If the side headgear straps are lying on your ears, adjust the top headgear strap to lift the headgear off of your ears. The headgear should lay flat against your head. If it is bunching, adjust the top headgear strap to allow the headgear to flatten.

### **Removing the Mask**

1. Disconnect the lower straps by removing one or both headgear clips or detaching one or both headgear straps from the faceplate.
2. Slide the headgear off over your head. The entire headgear stretches for easy removal.

### **Removing and Attaching the Cushions**

To Remove

1. Pull outward on the three attachment tabs on each side of the outer support cushion until this cushion separates from the mask frame.
2. Remove the outer support cushion.
3. Remove the inner sealing cushion with the blue flap.

### To Attach

1. Place the smaller inner sealing cushion on the mask frame (Figure 7).

**Note:**

The blue flap must cover the lip on the mask.

2. Slide the larger outer support cushion with tabs facing downward around the inner sealing cushion until all three sides click into the mask frame (Figure 8).
3. Gently tug on the cushions to make sure they are securely in place.
4. Gently press the forehead pad into the forehead pad slot in the mask frame.

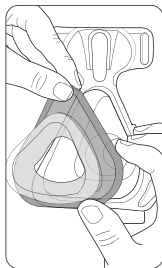

 **Figure 7**

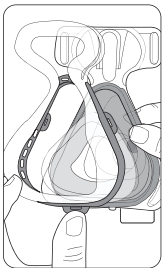

 **Figure 8**

## Specifications

 **Warning:** The technical specifications of the mask are provided for your healthcare professional to determine if it is compatible with your CPAP or bi-level therapy device. If used outside these specifications, or if used with incompatible devices, the mask may be uncomfortable, the seal of the mask may not be effective, optimum therapy may not be achieved, and leak, or variation in the rate of leak, may affect device function.



## Intentional Leak

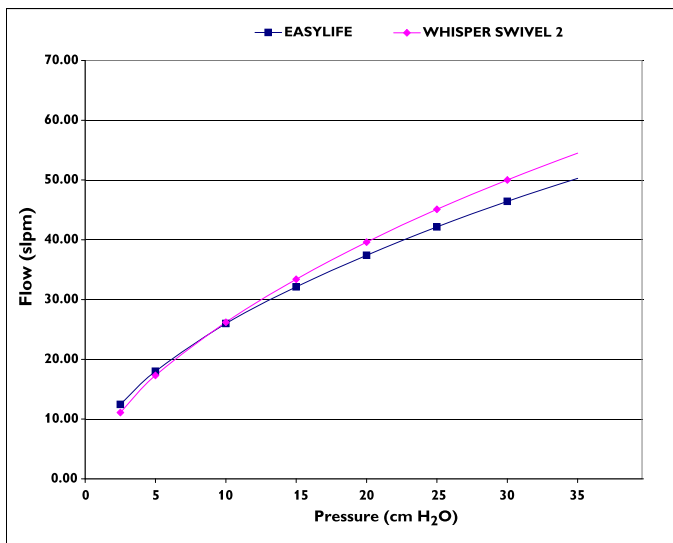

**Deadspace Volume**

P 50 mL

S 58 mL

M 65 mL

MW 81 mL

L 83 mL

**Pressure Drop  $\text{cmH}_2\text{O}$** 

	50 SLPM	100 SLPM
--	---------	----------

All mask sizes	0.2	0.7
----------------	-----	-----

**Disposal**

Dispose of in accordance with local regulations.

**Storage Conditions**

Temperature:  $-4^{\circ}$  to  $+140^{\circ}$  F ( $-20^{\circ}$  to  $+60^{\circ}$  C)

Relative Humidity: 15% to 95%, non-condensing

## LIMITED WARRANTY

Respironics, Inc. warrants that its mask systems (including mask frame and cushion) (the "Product") shall be free from defects of workmanship and materials for a period of ninety (90) days from the date of purchase (the "Warranty Period").

If the Product fails under normal conditions of use during the Warranty Period and the Product is returned to Respironics within the Warranty Period, Respironics will replace the Product. This warranty is non-transferable and only applies to the original owner of the Product. The foregoing replacement remedy will be the sole remedy for breach of the foregoing warranty. This warranty does not cover damage caused by accident, misuse, abuse, negligence, alteration, failure to use or maintain the Product under conditions of normal use and in accordance with the terms of the product literature, and other defects not related to materials or workmanship. This warranty does not apply to any Product that may have been repaired or altered by anyone other than Respironics.

Respironics disclaims all liability for economic loss, loss of profits, overhead, or indirect, consequential, special or incidental damages which may be claimed to arise from any sale or use of the Product. Some states do not allow the exclusion or limitation of incidental or consequential damages, so the above limitation or exclusion may not apply to you.

THIS WARRANTY IS GIVEN IN LIEU OF ALL OTHER EXPRESS WARRANTIES. IN ADDITION, ANY IMPLIED WARRANTY, INCLUDING ANY WARRANTY OF MERCHANTABILITY OR FITNESS FOR A PARTICULAR PURPOSE, IS SPECIFICALLY DISCLAIMED. SOME STATES DO NOT ALLOW DISCLAIMERS OF IMPLIED WARRANTIES, SO THE ABOVE LIMITATION MAY NOT APPLY TO YOU. THIS WARRANTY GIVES YOU SPECIFIC LEGAL RIGHTS, AND YOU MAY ALSO HAVE OTHER RIGHTS, WHICH VARY FROM STATE TO STATE.

To exercise your rights under this limited warranty, contact your local authorized Respironics, Inc. dealer or Respironics, Inc. at 1001 Murry Ridge Lane, Murrysville, Pennsylvania 15668, 1-800-345-6443 (USA and Canada only) or 1-724-387-4000.

---

## Reorder Numbers

1050000	EasyLife Mask W/Headgear, Petite
1050001	EasyLife Mask W/Headgear, Small
1050002	EasyLife Mask W/Headgear, Medium
1050003	EasyLife Mask W/Headgear, Medium Wide (MW)
1050004	EasyLife Mask W/Headgear, Large
1050005	EasyLife Mask Duopack W/Headgear, Petite
1050006	EasyLife Mask Duopack W/Headgear, Small
1050007	EasyLife Mask Duopack W/Headgear, Medium
1050008	EasyLife Mask Duopack W/Headgear, MW
1050009	EasyLife Mask Duopack W/Headgear, Large
1050010	EasyLife Mask W/O Headgear, Petite
1050011	EasyLife Mask W/O Headgear, Small
1050012	EasyLife Mask W/O Headgear, Medium
1050013	EasyLife Mask W/O Headgear, MW
1050014	EasyLife Mask W/O Headgear, Large
1050090	RP, EasyLife Cushion, Petite
1050091	RP, EasyLife Cushion, Small
1050092	RP, EasyLife Cushion, Medium
1050093	RP, EasyLife Cushion, MW
1050094	RP, EasyLife Cushion, Large
1050086	RP, RS EasyLife Headgear, TS
1050087	RP, EasyLife Headgear, TS
1050097	RP, EasyLife Headgear Clip